

# USER'S MANUAL

## ENTITY+ **Power Meter**

This document contains the latest technical information about Entity+ which is a micro-controller based Power Meter. The unit is tested against latest "MTE" Standard Model PRS400.3 having basic accuracy of 0.02%, traceable upto International Standards derived using appropriate ratio techniques.

The product, Entity+ is sophisticated electronic equipment, and the user is advised to read this User's Manual carefully before attempting to install or operate the equipment.

Published on: (mention the date of publishing)  
Document Version: 1.0

## **Warranty statement**

Trinity warrants to the original retail purchaser of the Trinity product enclosed with this limited warranty statement that the product, if purchased new and used in the India conforms to the manufacturer's specifications and will be free from defects in workmanship and materials for a period of one year from the date of original purchase, unless expressly stated otherwise by Trinity, in a written format.

Should your Trinity product prove defective during the warranty period, please bring the product securely packaged in its original container or an equivalent, along with proof of the date of original purchase, to our Trinity Dealer or Factory. You are responsible for all costs (shipping, insurance, travel time) in getting the product to the service location. Trinity will, at its option, repair or replace on an exchange basis the defective unit, without charge for parts or labor. When warranty service involves the exchange of the product or of a part, the item replaced becomes Trinity property. The replacement unit may be new or refurbished to the Trinity standard of quality, and at Trinity's option, the replacement may be another model of like kind and quality. Trinity's liability for replacement of the covered product will not exceed the original retail selling price of the covered product. Exchange or replacement products or parts assume the remaining warranty period of the product covered by this limited warranty.

### **What This Warranty Does Not Cover:**

This warranty does not apply to refurbished or reconditioned products. This warranty covers only normal use in India. This warranty does not cover damage to the Trinity product caused by parts or supplies not manufactured, distributed or certified by Trinity. This warranty is not transferable. This warranty does not cover third party parts, components or peripheral devices added to the Trinity product after its shipment from Trinity. Trinity is not responsible for warranty service should the Trinity label or logo or the rating label or serial number be removed or should the product fail to be properly maintained or fail to function properly as a result of misuse, abuse, improper installation, neglect, improper shipping, damage caused by disasters such as fire, flood, and lightning, improper electrical current, interaction with non-Trinity products, or service other than by an Trinity Authorized Service.

*The warranty and remedy provided above are exclusive and in lieu of all other express or implied warranties including, but not limited to, the implied warranties of merchantability or fitness for a particular purpose. In the event, the remedies above fail, Trinity's entire liability shall be limited to a refund of the price paid for the Trinity product covered by this limited warranty. Except as provided in this written warranty, neither Trinity Energy Systems Pvt. Ltd. nor its affiliates shall be liable for any loss, inconvenience, or damage, including direct, special, incidental, or consequential damages, resulting from the use or inability to use the Trinity product, whether resulting from breach of warranty or any other legal theory.*

## Contents

<b>Introduction .....</b>	<b>4</b>
The Main Features in This Model .....	4
Technical Specifications .....	5
<b>Installation and Commissioning.....</b>	<b>6</b>
Connection Scheme.....	7
RS485 CONNECTION.....	8
<b>Operational Details.....</b>	<b>9</b>
Programming Mode .....	9
Setting CT-Primary.....	9
Setting Device ID .....	10
Run Mode .....	11
Resetting Energies.....	13
<b>Communication .....</b>	<b>14</b>
Modbus RTU on RS485 Port .....	14
Appendix .....	15

## Introduction

Entity+ is based on proven microcontroller technology with front end ASICs, resulting in compact and accurate energy metering. The accuracy of the meter is maintained even under severely distorted waveform conditions which occur due to harmonics in the system.

Entity+ is a low cost effective, easy user interface that measures accurate energies (KWh, KVAh, KVARh), three phase voltage, three phase current, three voltages including PF, and displays on 16X1 LCD. The unit has also communication port, RS485 supporting MODBUS-RTU protocol for integration of SCADA/EMS. The unit should be used only for three phase four wire in an electrical installation.

### The Main Features in This Model

- Class 1.0S accuracy as per IS13779
- Microcontroller based with true RMS measurement
- Compact 96 x 96 x 55 mm enclosure along with 16x 1 LC Display
- Measurements of three energies (KWh, KVAh, KVARh)
- Measurements of voltage in phase to phase (Vry, Vyb, Vbr)
- Measurements of currents in three phases (Ir, Iy, Ib)
- Measurement of Voltage in Phase to neutral (Vrn, Vyn, Vbn)
- Measurement of three powers (KW, KVA, KVAR)
- Measurements of frequency and PF
- RS485 communication port on MODBUS- RTU protocol.



Technical Specifications

Parameter		
Type	Name	Statistics
INPUT	Supply	Three Phases and Neutral of a 3P4W system
	Voltage	Direct Voltage Input : Up to 300V L-N or 500V L-L Burden : 0.5VA
	Current (I <sub>r</sub> , I <sub>y</sub> , I <sub>b</sub> )	Secondary Current Input : 5A or 1A (optional) CT Primary : Site Selectable Range of Reading : 5 – 5000A Burden : < 1.0VA Overload (Through CT) : 5A CT = 6A RMS Continuous 1A CT = 1.2A RMS Continuous (Whole Current) : 120% of I <sub>max</sub> continuous.
	Power Supply	Wide operating Voltage SMPS : 80 VAC - 415 VAC, 50-60 Hz.
MEASUREMENT	Energy	Total Active Energy (KWh) Range of Reading : 0 to 9999999.0 Accuracy : 1.0S as per IS13779.
		Apparent Energy (KVAh) Range of Reading : 0 to 9999999.0 Accuracy : 1.0S as per IS13779.
		Reactive Energy (KVARh) Range of Reading : 0 to 9999999.0 Accuracy : 1.0S as per IS13779.
	Power	Active Power (KW) Accuracy : 1.0% of Reading
		Apparent Power(KVA) Accuracy : 1.0 % of Reading
		Reactive Power(KVAR) Accuracy : 1.5% of Reading (0.5 LAG to 0.8 LEAD)
	Power Factor (PF) Accuracy : 1.0 % of Reading ( PF ≥0.5) Range of Reading : 0.05 to 1.00 LAG/LEAD	
	Frequency (Hz) Range of Reading : 45 to 55 Hz Accuracy : 0.3% of Reading	
Communication Port		RS485 for integration with EMS/SCADA
MISCELLANEOUS	Dimensions	Bezel 96 X 96 mm
		Panel Cutout 92 X 92 mm
		Depth of installation 55 mm
	Display	16X1 LCD
	Operating temp	10°C to 50°C
	Weight	0.3 kg (approx.)
	Min. Operating Current	0.4% of CT-Primary.

\*To be specified at the time of ordering along with PT primary.

## Installation and Commissioning

The unit supports only for 3P4W electrical installation.

To install and commission the unit, proceed the following instructions:

1. Push the unit into the panel cutout and mount using the clamps provided.

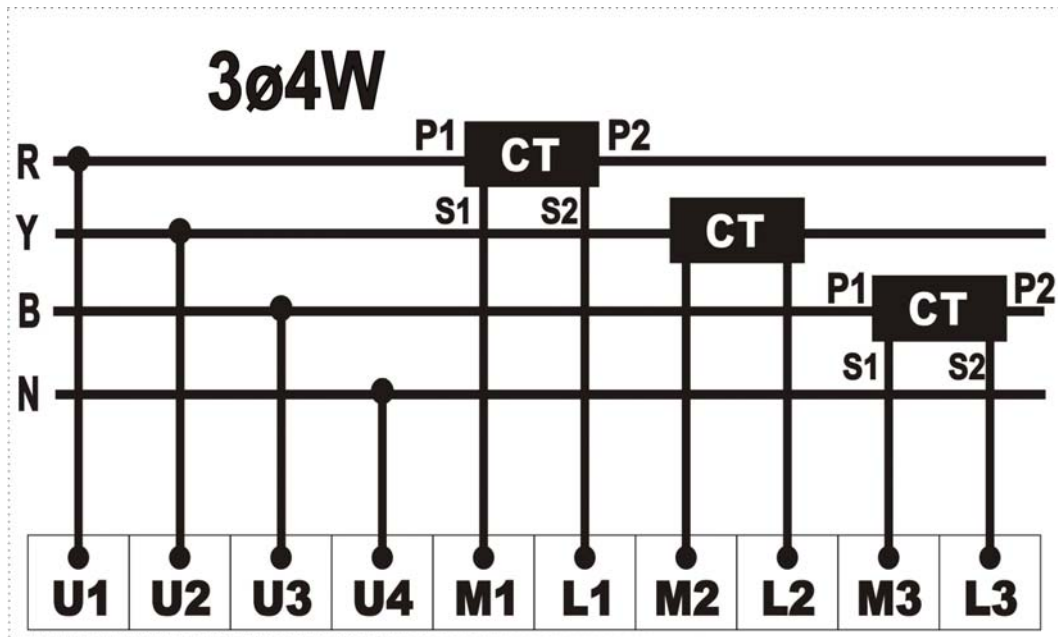

2. Connect the three phases with the sequence being R-Y-B to the terminals marked U1, U2 and U3. Make sure that the three phases coming to the unit come through control fuse of 1.0A rating. This will protect the electronics inside from damage and phase false due to sever over voltage.
3. Connect the Neutral wire to the terminal marked U4.
4. Connect the two wires coming from R-Phase CT to the terminals marked M1 and L1 such that S1 from CT goes to M1. Connect the two wires coming from Y-Phase CT to the terminal marked M2 and L2 such that S1 from CT goes to M2, and then connect the two wires coming from B-Phase CT to the terminal marked M3 and L3 such that S1 from CT goes to M3.
5. After that, connect the auxiliary supply to the terminal marked P and N for the self power supply to the unit.
6. First of all, set the programmable parameters such as CT-Primary and Device ID to give a true measurement of the system.
7. Now, the unit is ready for operation.

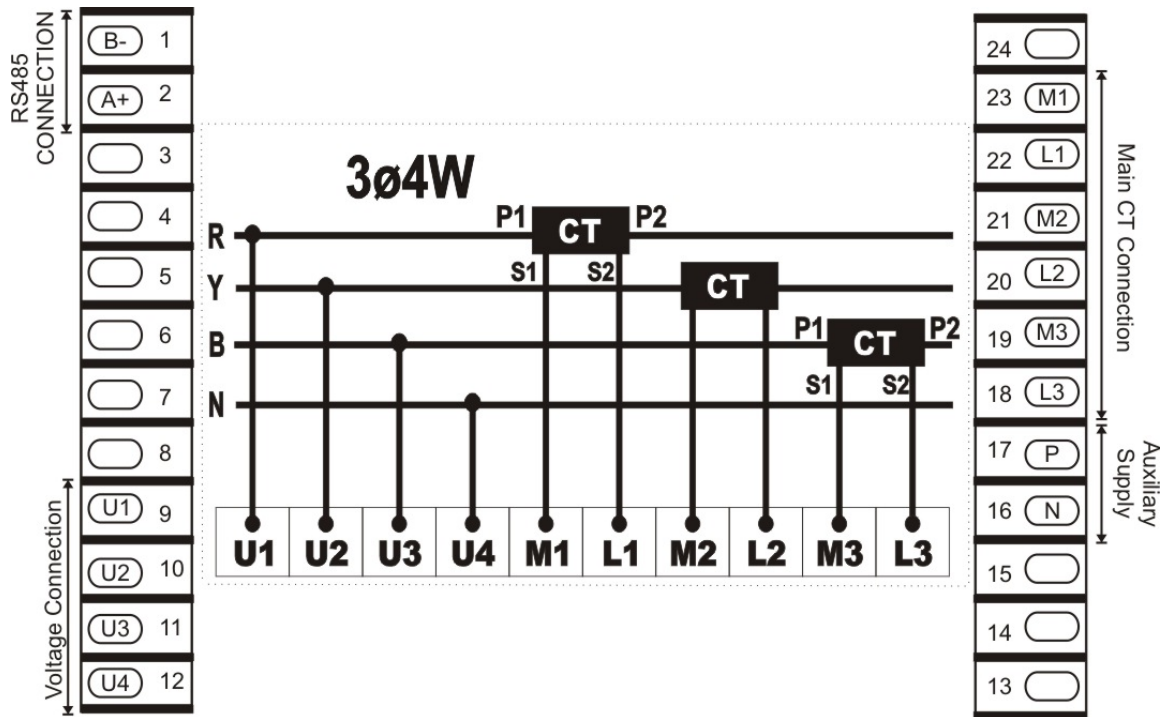

Connection Scheme

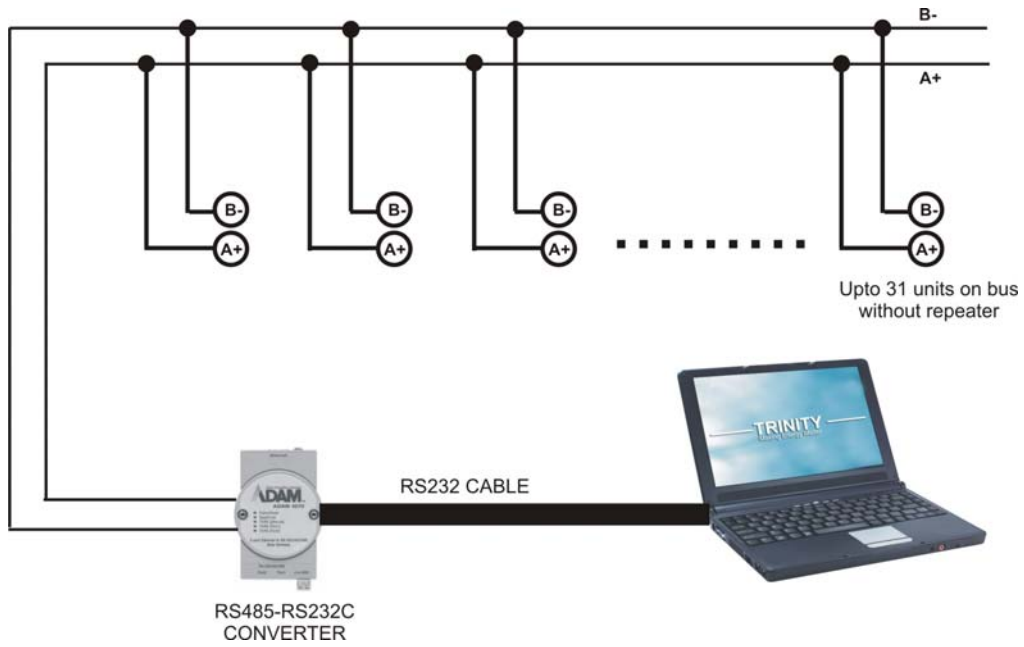

### RS485 CONNECTION



## Operational Details

The unit, Power Meter based, Entity+ is a versatile meter, with the features needed to implement for a robust electrical system. The unit can be configured to suit basic electrical parameters and communication needs, is also achieved by making as many parameters field programmable as much as possible.



There are two types of operational mode in Entity+.

1. Programming Mode.
2. Run Mode.

After supplying power (80 VAC to 415 VAC), the unit displays power receiving information such as "--TRINITY----", and then enters into Run Mode with the following display.



## Programming Mode

The unit is easy user interface for both the Programming Mode and Run mode. The unit can be operated by pressing the keys such as ,  and  keys. The unit consists of the following programmable parameters.



### Setting CT-Primary

The CT-Primary is freely programmable from 5 to 5000 A of which 5 to 200 can be set with the steps of 5 and 200 to 5000 with the steps of 25, and hence the CT setting falls onto the standard rating of user's desire. The CT setting thus gives the true current value for CT operated meter in your electrical installation system.

To set the CT-Primary, proceed the following instructions.

1. In Run Mode, press  key continuously, for about 3 to 4 seconds. The unit enters into Programming Mode such as shown below.





2. Press  key. Immediately, "P" starts blinking which shows that the unit can be set. Now, set the CT-Primary by pressing  and  keys till the desired value is received.

3. After setting the desired CT-Primary, press  key to confirm the setting. Simultaneously, the unit returns into Run Mode.





### Setting Device ID

The unit supports MODBUS-RTU protocol on RS485 and hence, for the communication of the parameters to each host, the Device ID should be set accordingly. The Device ID is freely settable from 1 to 255 with a fixed baud rate of 9600.

1. In Run Mode, press  key continuously, for about 3 to 4 seconds. The unit enters into Programming Mode such as shown below.











DEVICE ID=105

2. Press  key. Immediately, P starts blinking which shows that the unit can be set. Now, set the Device ID by pressing  and  keys till the desired value is received.
3. After setting the desired Device ID, press  key to confirm the setting. Simultaneously, the unit returns into Run Mode.

## Run Mode

In the run mode, the various parameters calculated by the Entity+ are displayed on different pages on a 16 X 1 backlit LC Display. The Run Mode shows the different parameters along with its system values. Those displays can be altered and analyzed one by one.

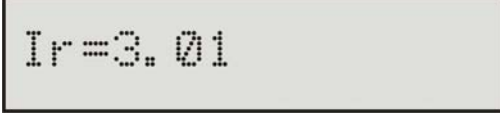
By default, Run Mode autoscrolls for all the Displays. According to user's requirements, the display can be frozen by pressing  key and the display can be altered by pressing  and  keys with the following pages.

Display in Run Mode	Descriptions
	The first display shows Active Energy (KWh).
	The second display shows phase to phase voltage (Vry).
	The third display shows phase to phase voltage (Vyb).
	The fourth display shows phase to phase voltage (Vbr).
	The fifth display shows R-Phase current.
	The sixth display shows Y-Phase current.

I<sub>b</sub>=4.09

The seventh display shows B-Phase current.

KVA=261.4

The eight display shows Apparent Power (KVA).

KW=258.7

The ninth display shows Active Power (KW).

KVAr=45.8

The tenth display shows Reactive Power (KVAr).

PF=1.000 LG

The eleventh display shows system PF. In case of PF unity, the display will show LEAD and LAG.

Freq=45.28 Hz

The twelfth display shows system frequency.

KVArh=1091.0

The thirteen display shows Reactive energy (KVArh).

KVAh=805.6

The fourteenth display shows Apparent energy (KVAh).

V<sub>r n</sub>=228.2

The fifteenth display shows phase to neutral voltage (V<sub>r n</sub>).



Vyn=226.3

The sixteenth display shows phase to neutral voltage (Vyn).



Vbn=230.3

The seventeenth display shows phase to neutral voltage (Vbn).

---

### Resetting Energies

The three energies such as KWh, KVAh and KVARh can be reset to zeroes. To reset for all three energies, in Run Mode, press  and  keys simultaneously for about 10 seconds or till the unit restarts. Now user can see in Run pages for all three energies which change to zeroes.

## Communication

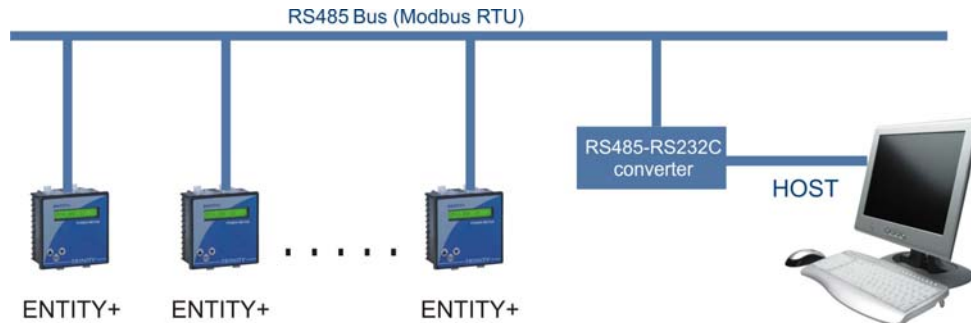

### UNIT CONNECTED TO RS485 PORT

The industrial standard RS-485 communication port option is also available in ENTITY+. This option makes it possible for a user to select ENTITY+ to provide power and energy information into a variety of existing or new control systems and communication networks such as EMS/PLS/SCADA.

#### Modbus RTU on RS485 Port

In order to download live data for the various system parameters, user can use RS485 connecting to a SCADA or EMS software. ENTITY+ supports an RS485 port with MODBUS-RTU protocol. The station ID for every meter is site selectable. The data which can be read using MODBUS query # 3 (Read Holding Registers) is provided in an address map, with the applicable multiplication factor,s, vide **Appendix**.

Communication line parameters: 9600/8/N/1.

The register map is described in Appendix. All addresses are in decimal whose parameters are unsigned long. If illegal address is sent in query or host, try to read more than 32 bytes of data in one query exception message is generated. The parameters name, address and multiplication factor are also mentioned.

Reserved values are for future uses which are transmitted as zeroes. Please refer to the address map for the various parameters in Appendix.

Appendix

3 phase 3000-3019	R phase 3030-3049	Y phase 3060-3079	B phase 3090-3109	MF
3000-KVA	3030-KWh	Reserved	Reserved	X100
3002-KW	3032-KVAh	Reserved	Reserved	X100
3004-KVAr	3034-KVARh	Reserved	Reserved	X100
3006-PF	3036-Hz	Reserved	Reserved	X1000
3008-Avg.VLL	3038-Vry	3068-Vyb	3098-Vbr	X100
3010-Avg. VLN	3040-Vrn	3070-Vyn	3100- Vbn	X100
3012-Avg. Amps.	3042-Ir	3072-ly	3102-lb	X100

DEFINING MULTIPLICATION FACTOR

- **Hz** has a multiplication factor of 100 & not 1000. e.g. If Hz is 48.33, and then it is sent as 4833.
- For providing resolution, all parameters except PT are multiplied with 100 before transmitting. Thus if the KVA value is 278.99, it is sent out as 27899. PF has MF of 1000, instead of 100. Thus, a PF value of 0.987 is sent as 987.
- If an attempt is made to read some address other than the valid addresses, the exception response is sent.

EXCEPTION CODE

In the event that the query from the HOST has no communication error, but there is some error in specifying the address of registers to be read, the meter returns an exception message. The format of the exception message will be such as table below:

Unit Address	0X83	Exception code	CRC	CRC
--------------	------	----------------	-----	-----

**Exception Code can have only one value, 02:** if the address is not a valid, start address or host has requested more than 32 bytes of data, this code is returned.

P.O No. : .....

Customer : .....

Sr. No. : .....

Routine and function tests conducted to relevant standards and our Specifications/Literature/O & M Manual.

Traceability: tested against "MTE" Standard Model PRS400.3 having basic accuracy of 0.02% traceable upto International Standards derived using appropriate ratio techniques.

Result of Test : .....

Remarks : .....

Test engineer : .....

Date : .....

---