

USER'S MANUAL

TINYPRO3 POWER METER

This document contains the latest technical information about TINYPRO3 which is a micro-controller based Power meter. The product Infinity is sophisticated electronic equipment, and the user is advised to read this User's Manual carefully before attempting to install or operate the equipment.

Published on: (mention the date of publishing)
Document Version: 1.0

Warranty statement

Trinity warrants to the original retail purchaser of the Trinity product enclosed with this limited warranty statement that the product, if purchased new and used in the India conforms to the manufacturer's specifications and will be free from defects in workmanship and materials for a period of one year from the date of original purchase, unless expressly stated otherwise by Trinity, in a written format.

Should your Trinity product prove defective during the warranty period, please bring the product securely packaged in its original container or an equivalent, along with proof of the date of original purchase, to our Trinity Dealer or Factory. You are responsible for all costs (shipping, insurance, travel time) in getting the product to the service location. Trinity will, at its option, repair or replace on an exchange basis the defective unit, without charge for parts or labor. When warranty service involves the exchange of the product or of a part, the item replaced becomes Trinity property. The replacement unit may be new or refurbished to the Trinity standard of quality, and at Trinity's option, the replacement may be another model of like kind and quality. Trinity's liability for replacement of the covered product will not exceed the original retail selling price of the covered product. Exchange or replacement products or parts assume the remaining warranty period of the product covered by this limited warranty.

What This Warranty Does Not Cover:

This warranty does not apply to refurbished or reconditioned products. This warranty covers only normal use in India. This warranty does not cover damage to the Trinity product caused by parts or supplies not manufactured, distributed or certified by Trinity. This warranty is not transferable. This warranty does not cover third party parts, components or peripheral devices added to the Trinity product after its shipment from Trinity. Trinity is not responsible for warranty service should the Trinity label or logo or the rating label or serial number be removed or should the product fail to be properly maintained or fail to function properly as a result of misuse, abuse, improper installation, neglect, improper shipping, damage caused by disasters such as fire, flood, and lightning, improper electrical current, interaction with non-Trinity products, or service other than by an Trinity Authorized Service.

The warranty and remedy provided above are exclusive and in lieu of all other express or implied warranties including, but not limited to, the implied warranties of merchantability or fitness for a particular purpose. In the event, the remedies above fail, Trinity's entire liability shall be limited to a refund of the price paid for the Trinity product covered by this limited warranty. Except as provided in this written warranty, neither Trinity Energy Systems Pvt. Ltd. nor its affiliates shall be liable for any loss, inconvenience, or damage, including direct, special, incidental, or consequential damages, resulting from the use or inability to use the Trinity product, whether resulting from breach of warranty or any other legal theory.

Contents

Introduction 4
 The Main Features Available in This Model..... 4
 Front View of the Unit 4
 Technical Specifications 5

Installation and Commissioning..... 6
 Connection Scheme..... 9
 RS485 Connection 10

Operational Details 11
 Programming Mode 12
 Setting CT- primary 12
 Setting a unit address for RS485 port..... 12
 Run Mode 14
 Run Mode Displays 14
 Freezing and unfreezing the displays 15

Communication 16
 Modbus RTU on RS485 Port 16
 Appendix 17

Ordering Options..... 18

Introduction

Tinypro3 is a microcontroller based power meter which measures basic parameters and displays on a red seven segment. Tinypro3 is a host of low cost, easy to use individually that offers for the basic measurement capabilities required to monitor electricity over and above basic metering. The unit can be installed to either 3P4W or 3P3W in an electrical installation and is able to measure parameters such as PF, Active power (KW) and Active Energy (KWh).

The unit also has communication, RS485 port supporting MODBUS-RTU protocol for integration with SCADA/EMS. The entire range is very rugged and cost-effective solution. The unit is field proven and more than 100,000 units are active in service.

The Main Features Available in This Model

- Multi parameter Monitoring with LED indicators
- Displays with 0.4 Red Seven Segment
- Measurement of KW, PF and KWh.
- Modbus-RTU on RS485 port with SCADA/EMS
- All parameters with default accuracy class 1.0S



Front View of the Unit

Technical Specifications

SR. NO	PARAMETERS & OPTIONS	STATASTICS	
1	Volts R-N	Direct Voltage Input	: Up to 300V L-N
2	Volts Y-N	Burden	: 0.5VA
3	Volts B-N	Secondary Voltage Input	: 63.5V*
4	Volts RY	Direct Voltage Input	: Up to 500V L-L
5	Volts YB	Burden	: 0.5VA
6	Volts BR	Secondary Voltage Input	: 110V*
7	Current R	Secondary Current Input	: 5A or 1A (To be specified at the time of Ordering)
8	Current Y	CT Primary	: Site Selectable
		Range of Reading	: 5 – 5000A
		Burden	: < 1.0VA
9	Current B	Overload(Through CT)	: 5A CT = 6A RMS Continuous 1A CT = 1.2A RMS Continuous
		(Whole Current)	: 120% of I _{max} continuous.
10	KWh	Range of Reading	: 0 to 9999999.0 KWh
		Accuracy	: 1.0S as per IS13779.
11	System PF	Accuracy	: 1% of Reading ($IPF \geq 0.5$)
		Range of Reading	: 0.05 to 1.00 Lag/Lead
12	System KW	Accuracy	: 1.0% of Reading (Between 0.5 Lag to 0.8 Lead)
13	DISPLAY	0.4" Red Seven Segment.	
14	RS485	For Integration with EMS/SCADA	
15	Bezel	96x96 mm	DIN enclosure
16	Depth	55 mm	

* To be specified at the time of ordering along with PT primary.

Installation and Commissioning

The unit can be used only for either 3P4W or 3P3W according to your ordering option and requirement in your electrical installation.

To install and commission for 3P4W, proceed the following instructions:

1. Push the unit into the panel and mount using the claim provided on it.

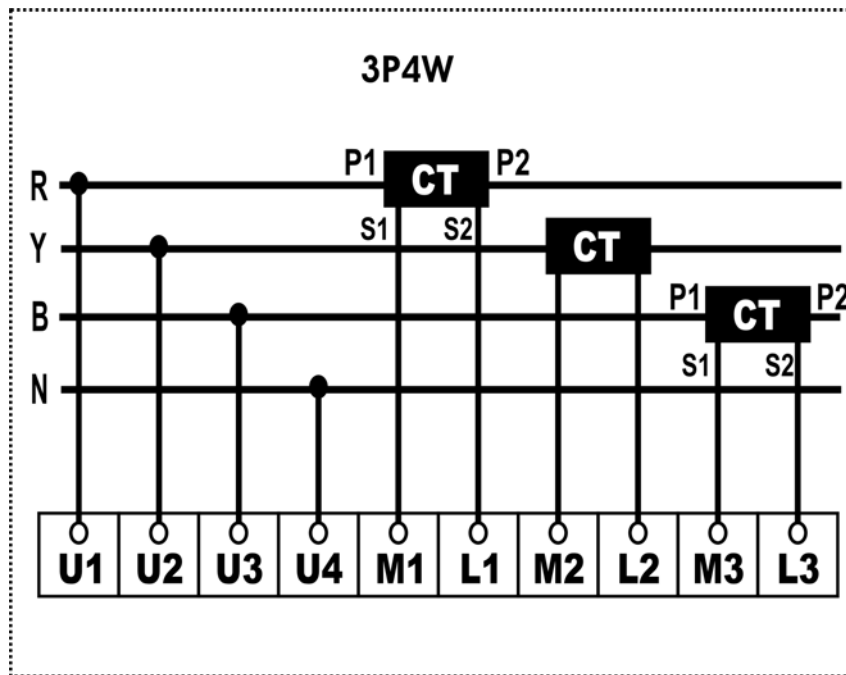

2. Connect the auxiliary supply (80V AC to 270V AC) to the terminals marked P and N.
3. Connect the three phases with the phase sequence being R-Y-B to the terminals marked U1, U2 and U3 respectively. Make sure that the phases coming to the unit come through control fuses of 1.0A rating. This will protect the electronic inside from damage due to severe over voltage or phase faults in the system.
4. Connect the neutral wire to the terminal marked U4.
5. Connect the two wires from the R-phase CT to the terminal marked M1 and L1 such that S1 from CT goes to M1. Connect the two wires from the Y-phase CT to the terminals marked M2 and L2 such that S1 from the CT goes to M2. Connect the two wires from the B-phase CT to the terminals marked M3 and L3 such that S1 from the CT goes to terminal marked M3.
6. Switch on the auxiliary supply as well as three phase supply and then, the unit will come alive in order to display such as TRINITY ESPL, CT ratio, Unit Address and Run Mode respectively.

7. Firstly, user should program the settable parameters, CT-primary and unit address for RS485 communication port. (*Refer Operational Details in the next section*).
8. Now the unit is ready for operation.

To install and commission for 3P3W, proceed the following instructions:

1. Push the unit into the panel and mount using the claim provided on it.

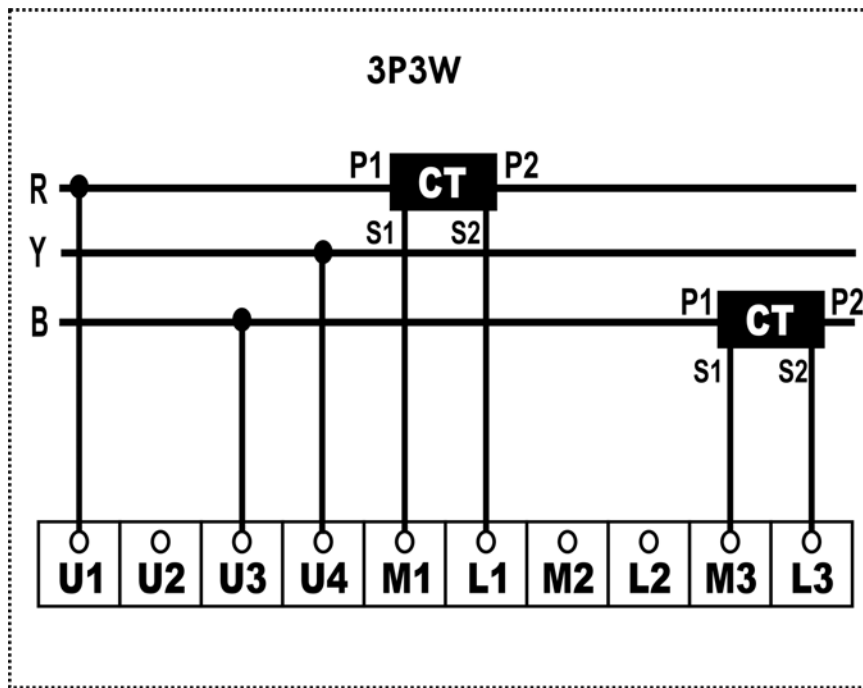

2. Connect the auxiliary supply (80V AC to 270V AC) to the terminals marked P and N.
3. Connect the three phases with the phase sequence being R-Y-B to the terminals marked U1, U4 and U3 respectively. Make sure that the phases coming to the unit come through control fuses of 1.0A rating. This will protect the electronic inside from damage due to severe over voltage or phase faults in the system.
4. Connect the two wires from the R-phase CT to the terminals marked M1 and L1 such that S1 from CT goes to M1. Connect the two wires from the B-phase CT to the terminals marked M3 and L3 such that S1 from the CT goes to the terminal marked M3.
5. Switch on the auxiliary supply as well as three phases supply and then, the unit will come alive in order to display such as TRINITY ESPL, CT ratio, unit Address and Run Mode respectively.
6. Firstly, user should program the settable parameters, CT-primary and unit address for RS485 communication port as required. (*Refer Operational Details in the next section*).
7. Now, the unit is ready for operation.

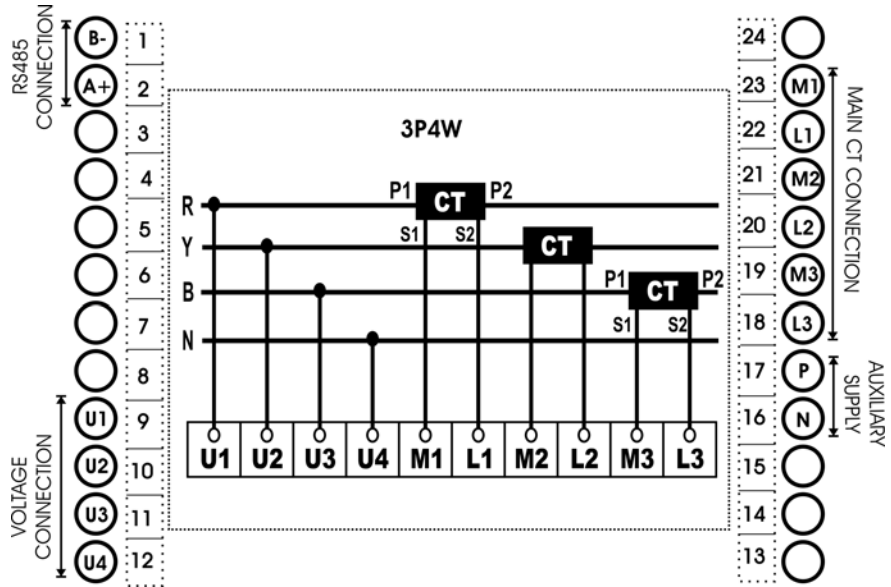

Connection Scheme

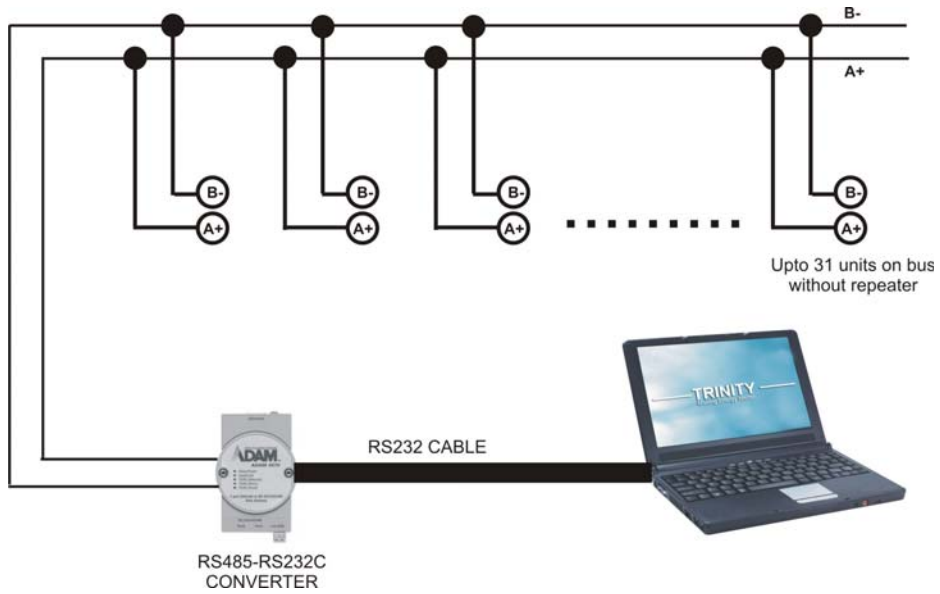

RS485 Connection

Operational Details

The Power Meter, TINYPRO3 is a versatile meter, with all the features needed to implement for a robust electrical load management system. It can be configured to monitor most electrical parameters and communication needs and, is also achieved by making field programmable parameters, as possible.

There are basically two modes of operation in TINYPRO3:

1. Programming Mode
2. Run Mode

After supplying power (80 VAC - 270 VAC), the unit displays immediately power receiving information, TRINITY ESPL on LCD screen and by default, the display comes into Run Mode such as shown below.

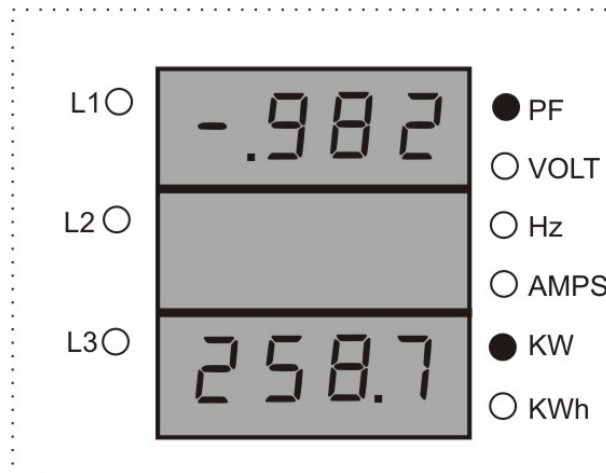





Now, the unit can be operated by using the following keypad provided for both the Programming Mode and Run Mode such as shown below.



Press  key on Run Mode for about five seconds continuously, the unit will therefore enter into Programming Mode, CT-PRIMARY with default value.

Programming Mode

In order to operate for all the field programmable parameters, it is easy for user interface by pressing the keys such as, ,  and  keys. Once the unit display is in CT-PRIMARY, press  key to move into the next programmable parameter, UNIT ADDRESS for RS485 communication.





Setting CT- primary

The CT-primary is settable from 5 to 5000 and, should be set so as to give actual current values in an electrical installation.

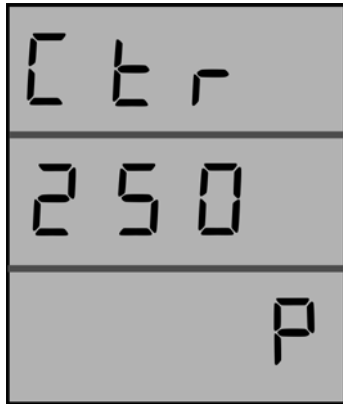
To set the CT-primary, proceed the following instruction:

1. Press  key for about 4 to 5 seconds on Run Mode display.
2. The unit will alter into Programming Mode display with settable parameter, CT-Primary such as shown below.



3. Press  key. Immediately, "P" starts blinking with an interval of one second which shows that the parameter is now settable. Set the CT-Primary by using  and  keys until the desired value is received and then press  key to confirm the set value.
4. Now, the unit will reset and return into Run Mode.





Setting a unit address for RS485 port

The unit has the provision to specify a meter address at site for RS485 port. This address can be set starting from 1 to 255 with a fixed baud rate of 9600.

To set the CT-Primary, proceed the following instruction:

1. Press  key for about 4 to 5 seconds on Run Mode display.
2. The unit will alter into Programming Mode display with the settable parameter, unit ADDRESS such as shown below.



3. Press  key. Immediately, "P" starts blinking with an interval of one second which shows that the parameter is now settable. Set the ADDRESS by using  and  keys until the desired value is received and then, press  key to confirm the set value.
4. Now, the unit will reset and return into Run Mode.

Run Mode

In the run mode, the various parameters calculated by the TINYPRO3 are displayed on different pages on a three lines of 0.4" Red Seven Segment. There are three parameters which displays in different pages with the system values. Now the displays can be altered and analyzed one by one.

Run Mode Displays

The Run Mode displays will autoscroll by default and stay for each page with an interval of 7 to 8 seconds.

Page 1

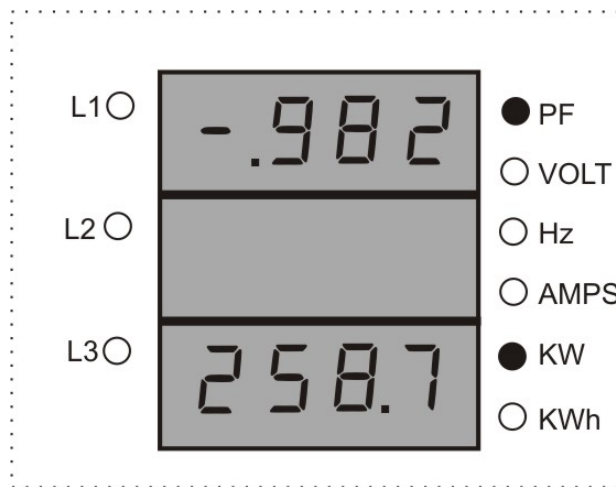

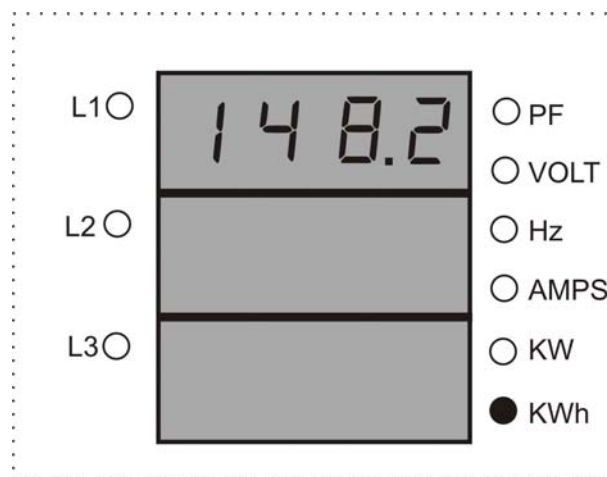

The LED indicators glow on system PF and Active Power (KW) which shows their values on first row and third row display respectively.

Page 2



The LED indicator glows on Total Active Energy (KWh) which shows its system value on first row display.

Freezing and unfreezing the displays

The Run Mode Displays enable to freeze and unfreeze by pressing  key, and then the LED indicator will start blinking which shows that the display is frozen. By pressing ▲ and ▼ keys, the pages can also be changed and analyzed for each parameter. To unfreeze the Run Mode, press  key again which will stop blinking the indicator and change the pages automatically in an interval of seven to eight seconds.

Communication

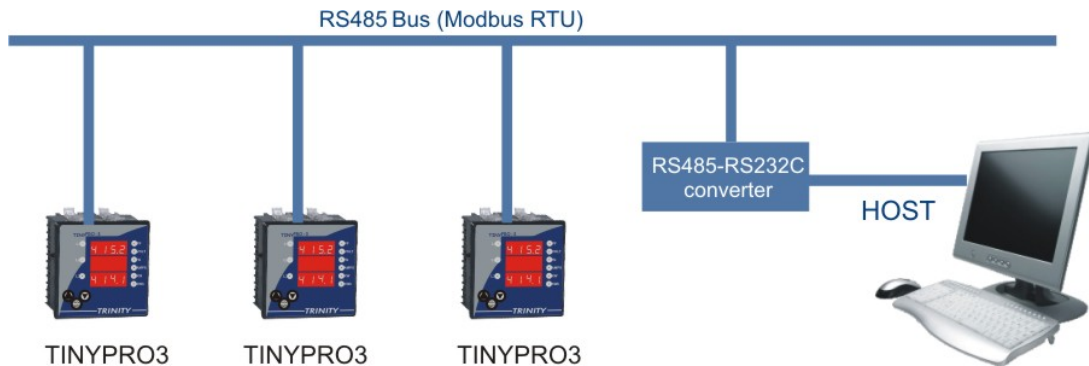

UNIT CONNECTED TO RS485 PORT

The industrial standard RS-485 communication port option is also available in TINYPRO3. This option makes it possible for a user to select TINYPRO3 to provide power and energy information into a variety of existing or new control systems and communication networks.

Modbus RTU on RS485 Port

In order to download live data for the various system parameters, user can use RS485 connecting to a SCADA or EMS software. TINYPRO3 supports an RS485 port with MODBUS-RTU support. The station id for every meter is site selectable, and so is the baud rate. The data which can be read using MODBUS query # 3 (Read Holding Registers) is provided in an address map, with the applicable multiplication factors, vide **Appendix**.

Communication line parameters: 9600/8/N/1.

The register map is described in Appendix. All addresses are in decimal whose parameters are unsigned long. If illegal address is sent in query or host, try to read more than 32 bytes of data in one query except message is generated. The parameters name, address and multiplication factor are also mentioned.

Reserved values are for future uses which are transmitted as zeroes. Please refer to the address map for the various parameters in Appendix.

Appendix

3 phase 3000-3019	R phase 3030-3049	Y phase 3060-3079	B phase 3090-3109	MF
Reserved	3030-KWh	Reserved	Reserved	X100
3002-KW	Reserved	Reserved	Reserved	X100
Reserved	Reserved	Reserved	Reserved	-
3006-PF	Reserved	Reserved	Reserved	X1000
Reserved	Reserved	Reserved	Reserved	-
Reserved	Reserved	Reserved	Reserved	-
Reserved	Reserved	Reserved	Reserved	-

DEFINING MULTIPLICATION FACTOR

- For providing resolution, all parameters except PT are multiplied with 100 before transmitting. Thus if the KW value is 278.99, it is sent out as 27899. PF has MF of 1000, instead of 100. Thus, a PF value of 0.987 is sent as 987.
- If an attempt is made to read some address other than the valid addresses, the exception response is sent.

EXPEPTION CODE

In the event that the query from the HOST has no communication error, but there is some error in specifying the address of registers to be read, the meter returns an exception message. The format of the exception message will be as under:

Unit Address	0X83	Exception code	CRC	CRC
--------------	------	----------------	-----	-----

Exception Code can have only one value, 03: if the address is not a valid, start address or host has requested more than 32 bytes of data, this code is returned.

Ordering Options

TINYPRO3 can be ordered with the following options according to your requirements.

TINYPRO3 Power Meter	
Technical Specification	Options
Installation	<input type="checkbox"/> 3P4W installation <input type="checkbox"/> 3P3W installation
For H.T application (only if meter is to be used for HT line)	PT-Primary.....KV. PT-secondary.....V.
CT secondary (Current)	<input type="checkbox"/> 5A <input type="checkbox"/> 1A
Communication	<input type="checkbox"/> RS485 port with Modbus-RTU protocol. <input type="checkbox"/> None

P.O No. :

Customer :

Sr. No. :

Routine and function tests conducted to relevant standards and our Specifications/Literature/O & M Manual.

Traceability: tested against "MTE" Standard Model PRS400.3 having basic accuracy of 0.02% traceable upto International Standards derived using appropriate ratio techniques.

Result of Test :

Remarks :

Test engineer :

Date :
